



Framia

Frameless elegance, harmony in every touch



- Frameless design curved on both left and right sides, 7.8mm thickness above the mounting surface
- Back Lite with long endurance LED illumination
- Safe and easy installation due to resin coated metal mounting plate
- A range of covers to suit commercial, residential and Hospitality applications

Framia

Frameless elegance,
harmony in every touch

The pursuit of beauty is a journey without end. The Framia series of frameless switches and sockets is ABB's profound understanding and respect for modern aesthetics. With its elegant design, smooth curves, and slim appearance, it skillfully combines simplicity with elegance and texture with aesthetics, creating a product that is both practical and beautiful. Integrating minimalist aesthetics into your daily life, it becomes an art piece on the wall.



Framia can perfectly blend into various scenarios such as hotels, homes, office buildings and other spaces. Whether they are modern and simple or classic and luxurious, Framia is your ideal choice.



Homes

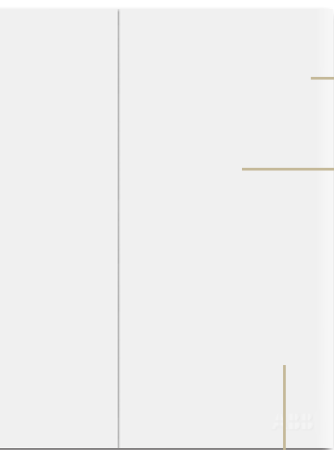

—● elegant surface

—● soft textures

—● timeless design

Framia is not just a light switch or a socket, but also a reflection of an attitude towards life. At ABB, we believe that good design can enhance the quality of life, and the Framia series with five colors is a manifestation of our commitment.



—
Electronic card switch, 16A

In the world of hospitality, the essence of comfort and convenience lies in the details. Framia is not merely a switch or socket, it is a statement of sophistication and a promise of exceptional guest experience. Framia refined aesthetics and intuitive functionality, is designed to meet the high standards of the hospitality industry. It's more than just a device to control lighting or power; it's an element that contributes to a seamless and luxurious guest environment.

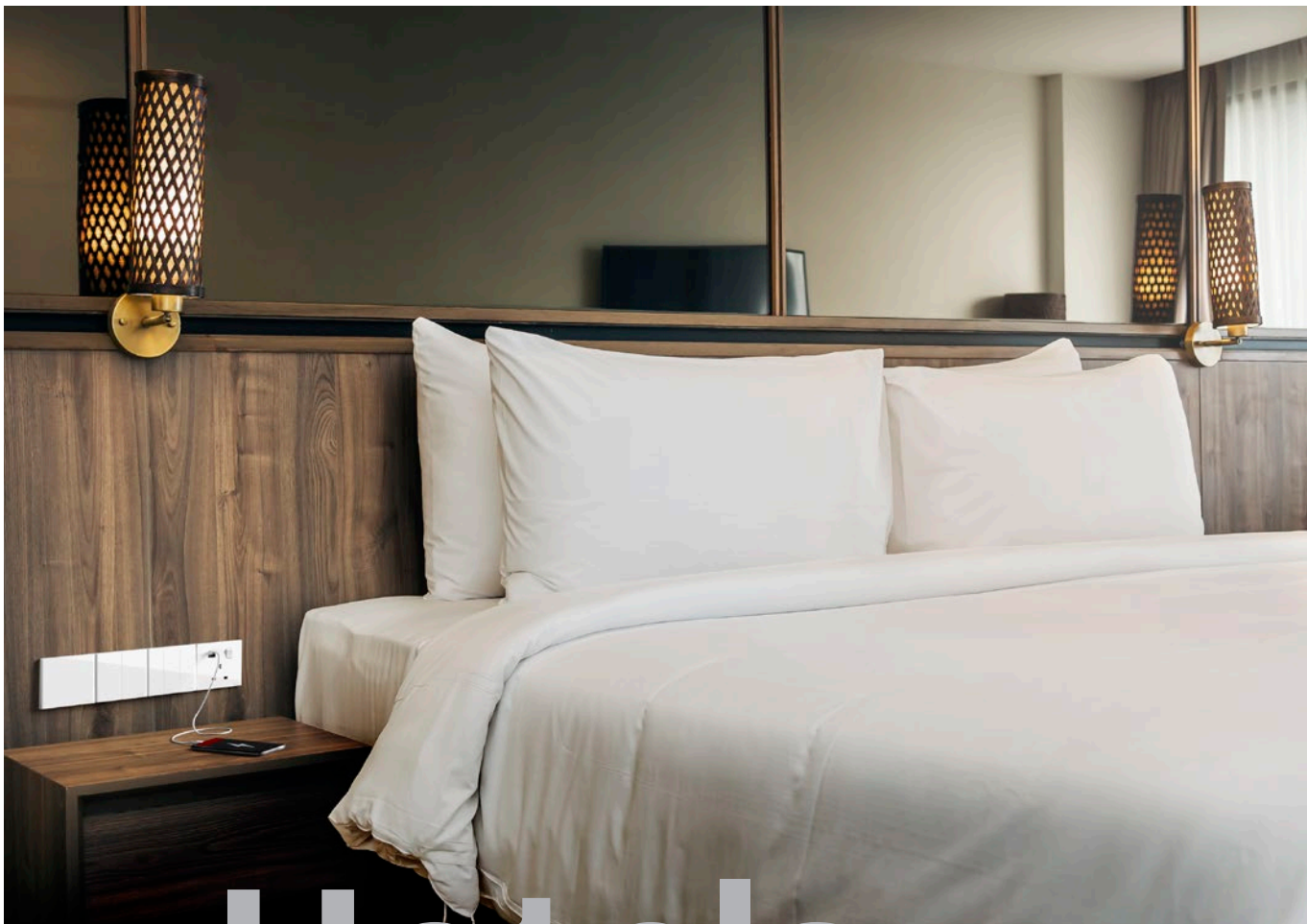

Hotels



Commercial building

The Framia series not only strives for perfection in design but also in material and craftsmanship. Made with high-quality plastics, copper and silver alloy materials, it ensures the safety and durability of the product perfect for high-traffic commercial spaces. Every touch conveys the delicacy and strength that comes from the material itself.

Minimalist aesthetics, trendsetting pioneer

The smooth frameless exterior, with a 7.8 mm slim body, integrates minimalist aesthetics into your daily life, becoming an art piece on the wall.



01

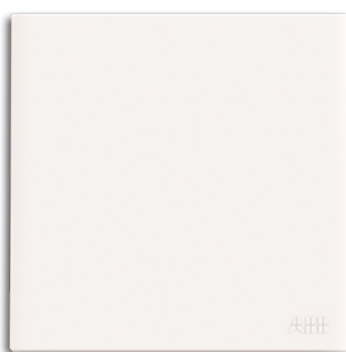

02



03



04



05

- 01 White
- 02 Matt white - WM
- 03 Space grey - SG
- 04 Matt black - MB
- 05 Champagne gold - CH

Features & benefits

Comprehensive functionality,
meeting diverse need

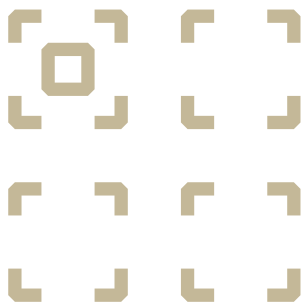

Excellent performance for durability

High quality PC material with improved flame retardants and UV stabilisers used to reduce possibilities of deformation and colour change due to exposure to sunlight.

High quality copper and silver alloy materials for metal parts to optimize life cycle performance.

All LED light indicators combine the attribute of low electricity consumption.

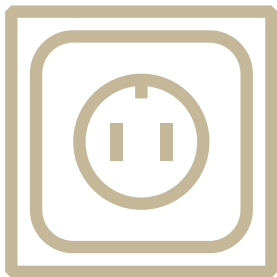

Wide variety of socket outlets

All sockets are equipped with shutters for increased safety. Switched and unswitched versions with and without LED indicator. 13A and 15A British standard, Multi-functional, Schuko and Euro American socket outlets.

USB Type-A+C integrated into BS and Multi-functional sockets, as well as the individual USB charger max output up to 65W.



Hospitality functions

Offers a wide range of products such as shaver socket outlet, electronic key card switch with time delay, bell switch (both indoor and outdoor) with "Do Not Disturb", "Make Up Room" with and indicators.

Safety first

Protecting every moment

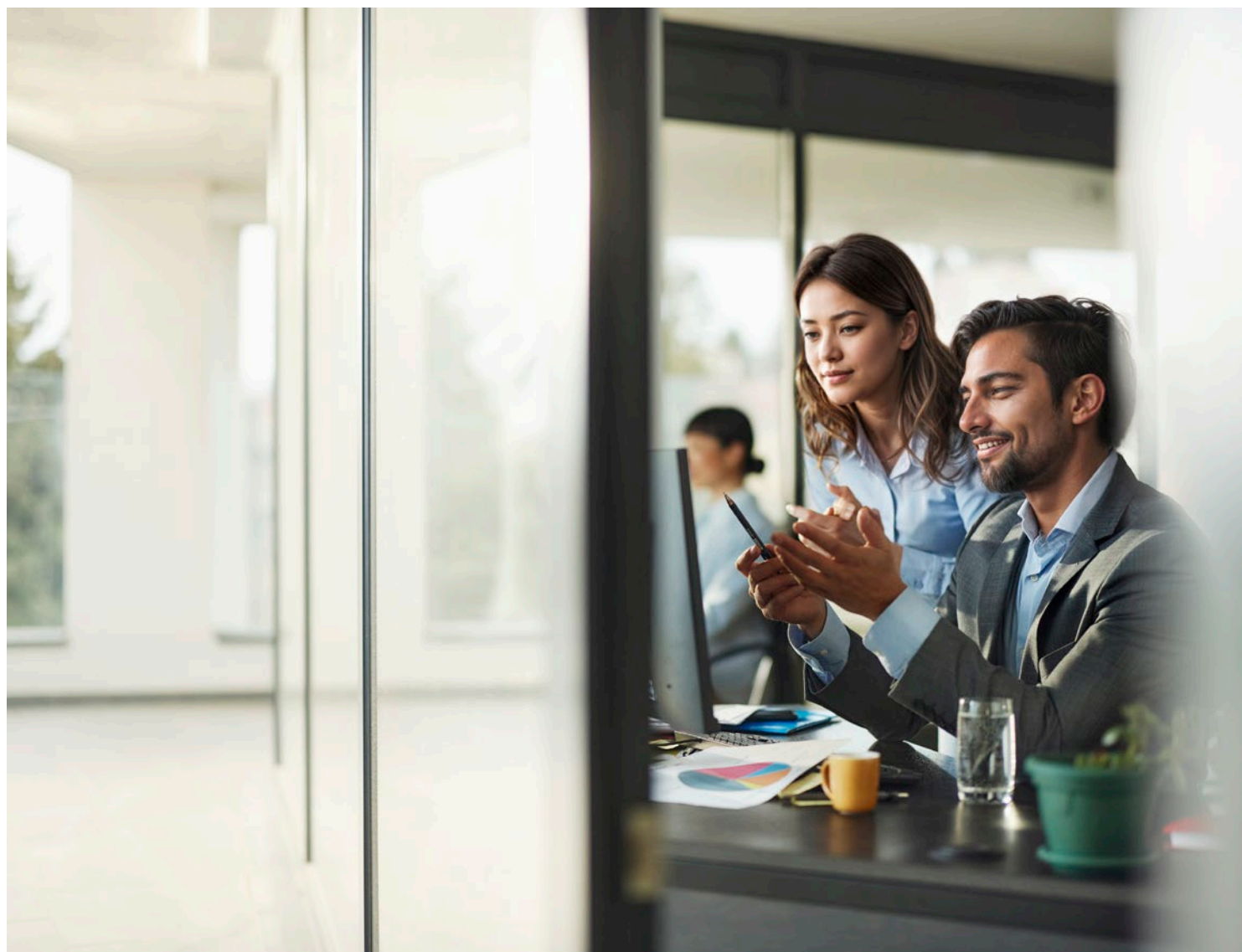

The Framia series is British standard-certified, made with high-quality plastics copper and silver alloy materials, ensuring safety and reliability with every use. The 16 AX switch ratings suitable for LED loads.

Easy installation

Saving time and effort

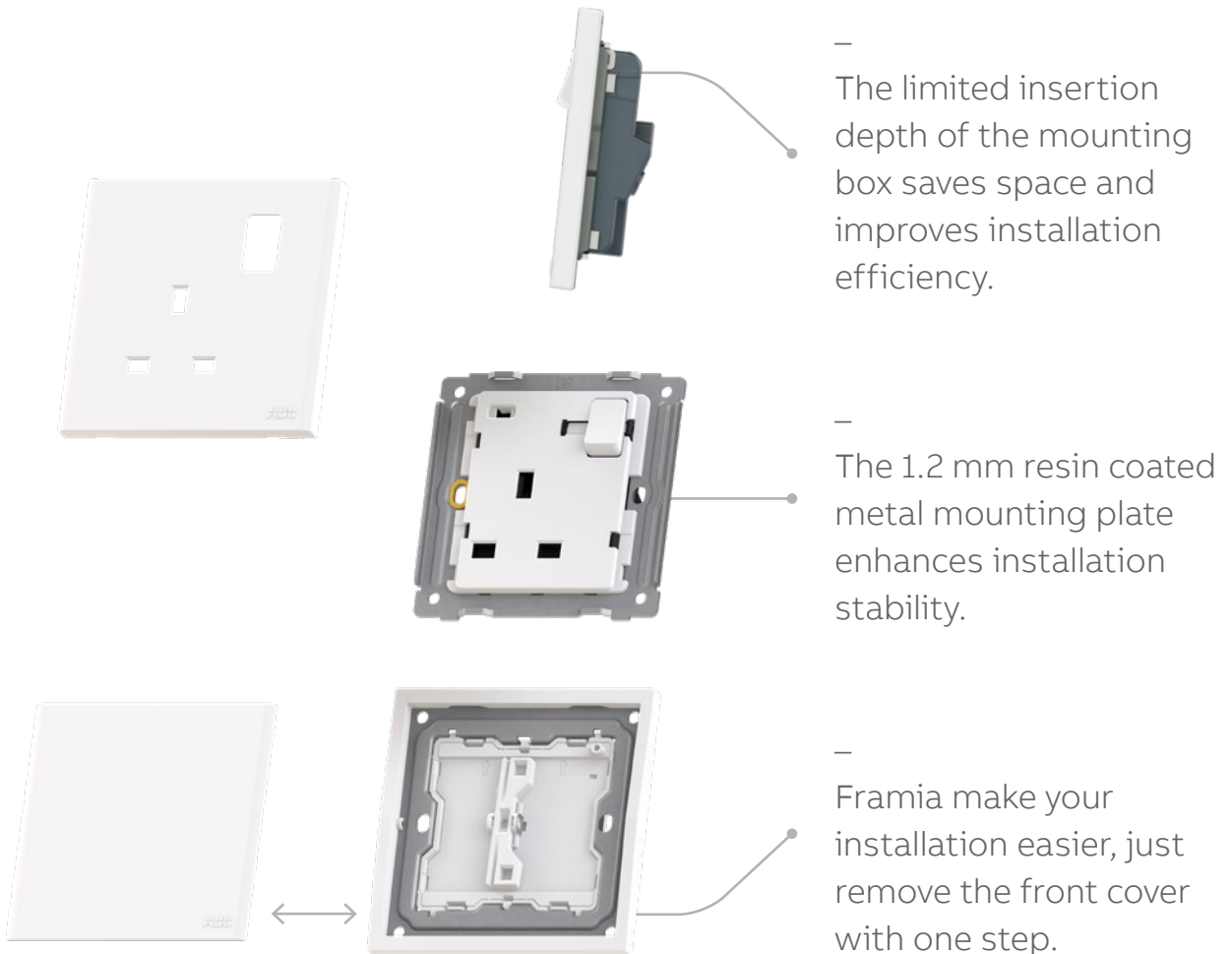
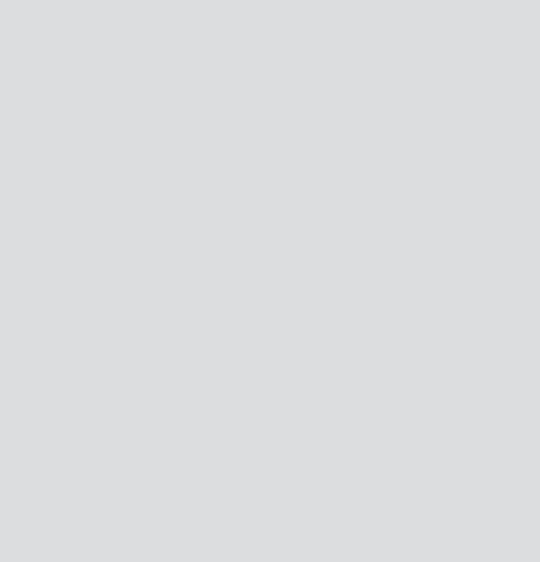



Framia

Switches

Product	Article-No.	Order-No.	Pack/Qty
	1 Gang 1 Way switch, 16AX Rated voltage: 250V AC Rated current: 16AX		
White	BC127	2TCZ211001R0060	1
Matt white	BC127-WM	2TCZ211001R3960	1
Space grey	BC127-SG	2TCZ211001R6360	1
Matt black	BC127-MB	2TCZ211001R4460	1
Champagne gold	BC127-CH	2TCZ211001R4160	1

	2 Gang 1 Way switch, 16AX Rated voltage: 250V AC Rated current: 16AX		
White	BC122	2TCZ211002R0060	1
Matt white	BC122-WM	2TCZ211002R3960	1
Space grey	BC122-SG	2TCZ211002R6360	1
Matt black	BC122-MB	2TCZ211002R4460	1
Champagne gold	BC122-CH	2TCZ211002R4160	1

	3 Gang 1 Way switch, 16AX Rated voltage: 250V AC Rated current: 16AX		
White	BC123	2TCZ211003R0060	1
Matt white	BC123-WM	2TCZ211003R3960	1
Space grey	BC123-SG	2TCZ211003R6360	1
Matt black	BC123-MB	2TCZ211003R4460	1
Champagne gold	BC123-CH	2TCZ211003R4160	1

	4 Gang 1 Way switch, 16AX Rated voltage: 250V AC Rated current: 16AX		
White	BC124	2TCZ211004R0060	1
Matt white	BC124-WM	2TCZ211004R3960	1
Space grey	BC124-SG	2TCZ211004R6360	1
Matt black	BC124-MB	2TCZ211004R4460	1
Champagne gold	BC124-CH	2TCZ211004R4160	1

Product	Article-No.	Order-No.	Pack/Qty
	1 Gang 2 Way switch, 16AX Rated voltage: 250V AC Rated current: 16AX		
White	BC125	2TCZ211005R0060	1
Matt white	BC125-WM	2TCZ211005R3960	1
Space grey	BC125-SG	2TCZ211005R6360	1
Matt black	BC125-MB	2TCZ211005R4460	1
Champagne gold	BC125-CH	2TCZ211005R4160	1

	2 Gang 2 Way switch, 16AX Rated voltage: 250V AC Rated current: 16AX		
White	BC126	2TCZ211006R0060	1
Matt white	BC126-WM	2TCZ211006R3960	1
Space grey	BC126-SG	2TCZ211006R6360	1
Matt black	BC126-MB	2TCZ211006R4460	1
Champagne gold	BC126-CH	2TCZ211006R4160	1

	3 Gang 2 Way switch, 16AX Rated voltage: 250V AC Rated current: 16AX		
White	BC121	2TCZ211007R0060	1
Matt white	BC121-WM	2TCZ211007R3960	1
Space grey	BC121-SG	2TCZ211007R6360	1
Matt black	BC121-MB	2TCZ211007R4460	1
Champagne gold	BC121-CH	2TCZ211007R4160	1

	4 Gang 2 Way switch, 16AX Rated voltage: 250V AC Rated current: 16AX		
White	BC141	2TCZ211008R0060	1
Matt white	BC141-WM	2TCZ211008R3960	1
Space grey	BC141-SG	2TCZ211008R6360	1
Matt black	BC141-MB	2TCZ211008R4460	1
Champagne gold	BC141-CH	2TCZ211008R4160	1

Framia

Switches

Product	Article-No.	Order-No.	Pack/Qty
	1 Gang 1 Way switch, 20AX Rated voltage: 250V AC Rated current: 20AX		
White	BC110	2TCZ211010R0070	1
Matt white	BC110-WM	2TCZ211010R3970	1
Space grey	BC110-SG	2TCZ211010R6370	1
Matt black	BC110-MB	2TCZ211010R4470	1
Champagne gold	BC110-CH	2TCZ211010R4170	1

	2 Gang 1 Way switch, 20AX Rated voltage: 250V AC Rated current: 20AX		
White	BC114	2TCZ211012R0070	1
Matt white	BC114-WM	2TCZ211012R3970	1
Space grey	BC114-SG	2TCZ211012R6370	1
Matt black	BC114-MB	2TCZ211012R4470	1
Champagne gold	BC114-CH	2TCZ211012R4170	1

	1 Gang 1 Way DP switch, 20AX Rated voltage: 250V AC Rated current: 20AX Marked "ON"		
White	BC111	2TCZ211014R0070	1
Matt white	BC111-WM	2TCZ211014R3970	1
Space grey	BC111-SG	2TCZ211014R6370	1
Matt black	BC111-MB	2TCZ211014R4470	1
Champagne gold	BC111-CH	2TCZ211014R4170	1

	1 Gang 1 Way DP switch with LED, 20AX Rated voltage: 250V AC Rated current: 20AX LED indicator Marked "ON"		
White	BC171	2TCZ211015R0070	1
Matt white	BC171-WM	2TCZ211015R3970	1
Space grey	BC171-SG	2TCZ211015R6370	1
Matt black	BC171-MB	2TCZ211015R4470	1
Champagne gold	BC171-CH	2TCZ211015R4170	1

Product	Article-No.	Order-No.	Pack/Qty
	1 Gang 2 Way switch, 20AX Rated voltage: 250V AC Rated current: 20AX		
White	BC112	2TCZ211011R0070	1
Matt white	BC112-WM	2TCZ211011R3970	1
Space grey	BC112-SG	2TCZ211011R6370	1
Matt black	BC112-MB	2TCZ211011R4470	1
Champagne gold	BC112-CH	2TCZ211011R4170	1

	2 Gang 2 Way switch, 20AX Rated voltage: 250V AC Rated current: 20AX		
White	BC115	2TCZ211013R0070	1
Matt white	BC115-WM	2TCZ211013R3970	1
Space grey	BC115-SG	2TCZ211013R6370	1
Matt black	BC115-MB	2TCZ211013R4470	1
Champagne gold	BC115-CH	2TCZ211013R4170	1

	2 Gang 1 Way DP switch, 20AX Rated voltage: 250V AC Rated current: 20AX Marked "ON"		
White	BC113	2TCZ211028R0070	1
Matt white	BC113-WM	2TCZ211028R3970	1
Space grey	BC113-SG	2TCZ211028R6370	1
Matt black	BC113-MB	2TCZ211028R4470	1
Champagne gold	BC113-CH	2TCZ211028R4170	1

	2 Gang 1 Way DP switch with LED, 20AX Rated voltage: 250V AC Rated current: 20AX LED indicator Marked "ON"		
White	BC178	2TCZ211029R0070	1
Matt white	BC178-WM	2TCZ211029R3970	1
Space grey	BC178-SG	2TCZ211029R6370	1
Matt black	BC178-MB	2TCZ211029R4470	1
Champagne gold	BC178-CH	2TCZ211029R4170	1

Framia

Switches

Product	Article-No.	Order-No.	Pack/Qty
	1 Gang 1 Way DP switch with LED, marked "Waterheater", 20AX Rated voltage: 250V AC Rated current: 20AX LED indicator Marked "ON" & "Waterheater"		
White	BC171WH	2TCZ211016R0070	1
Matt white	BC171WH-WM	2TCZ211016R3970	1
Space grey	BC171WH-SG	2TCZ211016R6370	1
Matt black	BC171WH-MB	2TCZ211016R4470	1
Champagne gold	BC171WH-CH	2TCZ211016R4170	1

	1 Gang 1 Way DP switch with LED, 32A Rated voltage: 250V AC Rated current: 32A LED indicator		
White	BC176	2TCZ211018R0090	1
Matt white	BC176-WM	2TCZ211018R3990	1
Space grey	BC176-SG	2TCZ211018R6390	1
Matt black	BC176-MB	2TCZ211018R4490	1
Champagne gold	BC176-CH	2TCZ211018R4190	1

	1 Gang 1 Way DP switch with LED, 32A Rated voltage: 250V AC Rated current: 32A LED indicator		
White	BC176W	2TCZ211018R0091	1
Matt white	BC176W-WM	2TCZ211018R3991	1
Space grey	BC176W-SG	2TCZ211018R6391	1
Matt black	BC176W-MB	2TCZ211018R4491	1
Champagne gold	BC176W-CH	2TCZ211018R4191	1

	1 Gang 1 Way push switch, 10A Rated voltage: 250V AC Rated current: 10A		
White	BC430	2TCZ211021R0030	1
Matt white	BC430-WM	2TCZ211021R3930	1
Space grey	BC430-SG	2TCZ211021R6330	1
Matt black	BC430-MB	2TCZ211021R4430	1
Champagne gold	BC430-CH	2TCZ211021R4130	1

Product	Article-No.	Order-No.	Pack/Qty
	1 Gang 2 Way DP switch with LED, marked "Waterheater", 20AX Rated voltage: 250V AC Rated current: 20AX LED indicator Marked "ON" & "Waterheater"		
White	BC180	2TCZ211017R0070	1
Matt white	BC180-WM	2TCZ211017R3970	1
Space grey	BC180-SG	2TCZ211017R6370	1
Matt black	BC180-MB	2TCZ211017R4470	1
Champagne gold	BC180-CH	2TCZ211017R4170	1

	1 Gang 1 Way DP switch with LED, 45A Rated voltage: 250V AC Rated current: 45A LED indicator		
White	BC177	2TCZ211019R0090	1
Matt white	BC177-WM	2TCZ211019R3990	1
Space grey	BC177-SG	2TCZ211019R6390	1
Matt black	BC177-MB	2TCZ211019R4490	1
Champagne gold	BC177-CH	2TCZ211019R4190	1

	1 Gang 1 Way DP switch with LED, 45A Rated voltage: 250V AC Rated current: 45A LED indicator		
White	BC177W	2TCZ211019R0091	1
Matt white	BC177W-WM	2TCZ211019R3991	1
Space grey	BC177W-SG	2TCZ211019R6391	1
Matt black	BC177W-MB	2TCZ211019R4491	1
Champagne gold	BC177W-CH	2TCZ211019R4191	1

	1 Gang 2 Way push switch, 10A Rated voltage: 250V AC Rated current: 10A		
White	BC456	2TCZ211022R0030	1
Matt white	BC456-WM	2TCZ211022R3930	1
Space grey	BC456-SG	2TCZ211022R6330	1
Matt black	BC456-MB	2TCZ211022R4430	1
Champagne gold	BC456-CH	2TCZ211022R4130	1

Framia

Switches

Product	Article-No.	Order-No.	Pack/Qty
	2 Gang 1 Way push switch, 10A Rated voltage: 250V AC Rated current: 10A		
White	BC438	2TCZ211023R0030	1
Matt white	BC438-WM	2TCZ211023R3930	1
Space grey	BC438-SG	2TCZ211023R6330	1
Matt black	BC438-MB	2TCZ211023R4430	1
Champagne gold	BC438-CH	2TCZ211023R4130	1

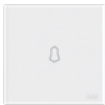
	Push switch with bell symbol, 10A Rated voltage: 250V AC Rated current: 10A Bell symbol		
White	BC429	2TCZ211020R0030	1
Matt white	BC429-WM	2TCZ211020R3930	1
Space grey	BC429-SG	2TCZ211020R6330	1
Matt black	BC429-MB	2TCZ211020R4430	1
Champagne gold	BC429-CH	2TCZ211020R4130	1

	Intermediate switch, 16AX Rated voltage: 250V AC Rated current: 16AX		
White	BC150	2TCZ211009R0060	1
Matt white	BC150-WM	2TCZ211009R3960	1
Space grey	BC150-SG	2TCZ211009R6360	1
Matt black	BC150-MB	2TCZ211009R4460	1
Champagne gold	BC150-CH	2TCZ211009R4160	1

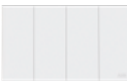
	4 Gang 2 Way switch in 6x3 Size, 16AX Rated voltage: 250V AC Rated current: 16AX Size: in 6x3		
White	BC191	2TCZ211026R0060	1
Matt white	BC191-WM	2TCZ211026R3960	1
Space grey	BC191-SG	2TCZ211026R6360	1
Matt black	BC191-MB	2TCZ211026R4460	1
Champagne gold	BC191-CH	2TCZ211026R4160	1

Product	Article-No.	Order-No.	Pack/Qty
	3 Gang 1 Way push switch, 10A Rated voltage: 250V AC Rated current: 10A		
White	BC439	2TCZ211030R0030	1
Matt white	BC439-WM	2TCZ211030R3930	1
Space grey	BC439-SG	2TCZ211030R6330	1
Matt black	BC439-MB	2TCZ211030R4430	1
Champagne gold	BC439-CH	2TCZ211030R4130	1

	Switch blind control Rated voltage: 250V AC Rated current: 10A		
White	BC149	2TCZ211024R0030	1
Matt white	BC149-WM	2TCZ211024R3930	1
Space grey	BC149-SG	2TCZ211024R6330	1
Matt black	BC149-MB	2TCZ211024R4430	1
Champagne gold	BC149-CH	2TCZ211024R4130	1

	2 Gang 1 Way DP 45A switch & 13A switched socket outlet with LED Rated voltage: 250V AC Rated current (socket): 13A Rated current (switch): 45A LED indicator		
White	BC118	2TCZ211025R0090	1
Matt white	BC118-WM	2TCZ211025R3990	1
Space grey	BC118-SG	2TCZ211025R6390	1
Matt black	BC118-MB	2TCZ211025R4490	1
Champagne gold	BC118-CH	2TCZ211025R4190	1

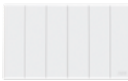
	6 Gang 2 Way switch in 6x3 Size, 16AX Rated voltage: 250V AC Rated current: 16AX Size: in 6x3		
White	BC198	2TCZ211027R0060	1
Matt white	BC198-WM	2TCZ211027R3960	1
Space grey	BC198-SG	2TCZ211027R6360	1
Matt black	BC198-MB	2TCZ211027R4460	1
Champagne gold	BC198-CH	2TCZ211027R4160	1

Framia

Socket outlets

Product	Article-No.	Order-No.	Pack/Qty
	1 Gang unswitched socket outlet, 13A Rated voltage: 250V AC Rated current: 13A Includes child safety shutter		
White	BC208	2TCZ212001R0040	1
Matt white	BC208-WM	2TCZ212001R3940	1
Space grey	BC208-SG	2TCZ212001R6340	1
Matt black	BC208-MB	2TCZ212001R4440	1
Champagne gold	BC208-CH	2TCZ212001R4140	1

	1 Gang SP switched socket outlet, 13A Rated voltage: 250V AC Rated current: 13A Single pole switch Includes child safety shutter		
White	BC224	2TCZ212002R0040	1
Matt white	BC224-WM	2TCZ212002R3940	1
Space grey	BC224-SG	2TCZ212002R6340	1
Matt black	BC224-MB	2TCZ212002R4440	1
Champagne gold	BC224-CH	2TCZ212002R4140	1

	1 Gang SP switched socket outlet with LED, 13A Rated voltage: 250V AC Rated current: 13A Single pole switch LED indicator Includes child safety shutter		
White	BC229	2TCZ212003R0040	1
Matt white	BC229-WM	2TCZ212003R3940	1
Space grey	BC229-SG	2TCZ212003R6340	1
Matt black	BC229-MB	2TCZ212003R4440	1
Champagne gold	BC229-CH	2TCZ212003R4140	1

	1 Gang DP switched socket outlet, 13A Rated voltage: 250V AC Rated current: 13A Double pole switch Includes child safety shutter		
White	BC237	2TCZ212004R0040	1
Matt white	BC237-WM	2TCZ212004R3940	1
Space grey	BC237-SG	2TCZ212004R6340	1
Matt black	BC237-MB	2TCZ212004R4440	1
Champagne gold	BC237-CH	2TCZ212004R4140	1

Product	Article-No.	Order-No.	Pack/Qty
	2 Gang unswitched socket outlet, 13A Rated voltage: 250V AC Rated current: 13A Includes child safety shutter		
White	BC260	2TCZ212006R0040	1
Matt white	BC260-WM	2TCZ212006R3940	1
Space grey	BC260-SG	2TCZ212006R6340	1
Matt black	BC260-MB	2TCZ212006R4440	1
Champagne gold	BC260-CH	2TCZ212006R4140	1

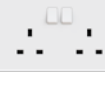
	2 Gang SP switched socket outlet, 13A Rated voltage: 250V AC Rated current: 13A Single pole switch Includes child safety shutter		
White	BC227	2TCZ212007R0040	1
Matt white	BC227-WM	2TCZ212007R3940	1
Space grey	BC227-SG	2TCZ212007R6340	1
Matt black	BC227-MB	2TCZ212007R4440	1
Champagne gold	BC227-CH	2TCZ212007R4140	1

	2 Gang SP switched socket outlet with LED, 13A Rated voltage: 250V AC Rated current: 13A Single pole switch LED indicator Includes child safety shutter		
White	BC200	2TCZ212008R0040	1
Matt white	BC200-WM	2TCZ212008R3940	1
Space grey	BC200-SG	2TCZ212008R6340	1
Matt black	BC200-MB	2TCZ212008R4440	1
Champagne gold	BC200-CH	2TCZ212008R4140	1

	2 Gang DP switched socket outlet, 13A Rated voltage: 250V AC Rated current: 13A Double pole switch Includes child safety shutter		
White	BC239	2TCZ212009R0040	1
Matt white	BC239-WM	2TCZ212009R3940	1
Space grey	BC239-SG	2TCZ212009R6340	1
Matt black	BC239-MB	2TCZ212009R4440	1
Champagne gold	BC239-CH	2TCZ212009R4140	1

Framia

Socket outlets

Product	Article-No.	Order-No.	Pack/Qty
	1 Gang DP switched socket outlet with LED, 13A Rated voltage: 250V AC Rated current: 13A Double pole switch LED indicator Includes child safety shutter		
White	BC238	2TCZ212005R0040	1
Matt white	BC238-WM	2TCZ212005R3940	1
Space grey	BC238-SG	2TCZ212005R6340	1
Matt black	BC238-MB	2TCZ212005R4440	1
Champagne gold	BC238-CH	2TCZ212005R4140	1

	1 Gang DP switched socket outlet with USB Type A+C, 13A Rated voltage: 250V AC Rated current: 13A Double pole switch USB-C: 20W Max. USB-A: 18W Max. USB-A+C: 15W Max. Includes child safety shutter		
White	BC247	2TCZ212011R0040	1
Matt white	BC247-WM	2TCZ212011R3940	1
Space grey	BC247-SG	2TCZ212011R6340	1
Matt black	BC247-MB	2TCZ212011R4440	1
Champagne gold	BC247-CH	2TCZ212011R4140	1

	1 Gang switched Multi- Socket Outlet, 16A Rated voltage: 250V AC Rated current: 16A Single pole switch Includes child safety shutter		
White	BC294	2TCZ212013R0060	1
Matt white	BC294-WM	2TCZ212013R3960	1
Space grey	BC294-SG	2TCZ212013R6360	1
Matt black	BC294-MB	2TCZ212013R4460	1
Champagne gold	BC294-CH	2TCZ212013R4160	1

	1 Gang switched Multi- Socket Outlet with USB Type A+C, 16A Rated voltage: 250V AC Rated current: 16A Single pole switch USB-C: 20W Max. USB-A: 18W Max. USB-A+C: 15W Max. Includes child safety shutter		
White	BC251	2TCZ212014R0060	1
Matt white	BC251-WM	2TCZ212014R3960	1
Space grey	BC251-SG	2TCZ212014R6360	1
Matt black	BC251-MB	2TCZ212014R4460	1
Champagne gold	BC251-CH	2TCZ212014R4160	1

Product	Article-No.	Order-No.	Pack/Qty
	2 Gang DP switched socket outlet with LED, 13A Rated voltage: 250V AC Rated current: 13A Double pole switch LED indicator Includes child safety shutter		
White	BC240	2TCZ212010R0040	1
Matt white	BC240-WM	2TCZ212010R3940	1
Space grey	BC240-SG	2TCZ212010R6340	1
Matt black	BC240-MB	2TCZ212010R4440	1
Champagne gold	BC240-CH	2TCZ212010R4140	1

	2 Gang DP switched socket outlet with USB Type A+C, 13A Rated voltage: 250V AC Rated current: 13A Double pole switch USB-C: 20W Max. USB-A: 18W Max. USB-A+C: 15W Max. Includes child safety shutter		
White	BC248	2TCZ212012R0040	1
Matt white	BC248-WM	2TCZ212012R3940	1
Space grey	BC248-SG	2TCZ212012R6340	1
Matt black	BC248-MB	2TCZ212012R4440	1
Champagne gold	BC248-CH	2TCZ212012R4140	1

	2 Gang switched Multi- Socket Outlet, 16A Rated voltage: 250V AC Rated current: 16A Single pole switch Includes child safety shutter		
White	BC253	2TCZ212023R0060	1
Matt white	BC253-WM	2TCZ212023R3960	1
Space grey	BC253-SG	2TCZ212023R6360	1
Matt black	BC253-MB	2TCZ212023R4460	1
Champagne gold	BC253-CH	2TCZ212023R4160	1

	2 Gang switched Multi- Socket Outlet with USB Type A+C, 16A Rated voltage: 250V AC Rated current: 16A Single pole switch USB-C: 20W Max. USB-A: 18W Max. USB-A+C: 15W Max. Includes child safety shutter		
White	BC250	2TCZ212015R0060	1
Matt white	BC250-WM	2TCZ212015R3960	1
Space grey	BC250-SG	2TCZ212015R6360	1
Matt black	BC250-MB	2TCZ212015R4460	1
Champagne gold	BC250-CH	2TCZ212015R4160	1

Framia

Socket outlets

Product	Article-No.	Order-No.	Pack/Qty
	USB charger, Type A+C USB-C: 65W Max. USB-A: 45W Max. USB-A+C: 10W+45W Max.		
White	BC249	2TCZ212016R0010	1
Matt white	BC249-WM	2TCZ212016R3910	1
Space grey	BC249-SG	2TCZ212016R6310	1
Matt black	BC249-MB	2TCZ212016R4410	1
Champagne gold	BC249-CH	2TCZ212016R4110	1

Product	Article-No.	Order-No.	Pack/Qty
	1 Gang round pin switched socket outlet, 15A Rated voltage: 250V AC Rated current: 5A Single pole switch Includes child safety shutter		
White	BC252	2TCZ212017R0020	1
Matt white	BC252-WM	2TCZ212017R3920	1
Space grey	BC252-SG	2TCZ212017R6320	1
Matt black	BC252-MB	2TCZ212017R4420	1
Champagne gold	BC252-CH	2TCZ212017R4120	1

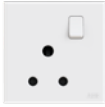
	1 Gang round pin switched socket outlet, 5A Rated voltage: 250V AC Rated current: 15A Single pole switch Includes child safety shutter		
White	BC209	2TCZ212018R0050	1
Matt white	BC209-WM	2TCZ212018R3950	1
Space grey	BC209-SG	2TCZ212018R6350	1
Matt black	BC209-MB	2TCZ212018R4450	1
Champagne gold	BC209-CH	2TCZ212018R4150	1

	2 Gang Euro-American switched socket outlet, 10A Rated voltage: 250V AC Rated current: 10A Single pole switch Includes child safety shutter		
White	BC222	2TCZ212020R0030	1
Matt white	BC222-WM	2TCZ212020R3930	1
Space grey	BC222-SG	2TCZ212020R6330	1
Matt black	BC222-MB	2TCZ212020R4430	1
Champagne gold	BC222-CH	2TCZ212020R4130	1

	1 Gang Euro-American socket outlet with earth, 16A Rated voltage: 250V AC Rated current: 16A Includes child safety shutter		
White	BC244	2TCZ212021R0060	1
Matt white	BC244-WM	2TCZ212021R3960	1
Space grey	BC244-SG	2TCZ212021R6360	1
Matt black	BC244-MB	2TCZ212021R4460	1
Champagne gold	BC244-CH	2TCZ212021R4160	1

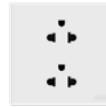
	2 Gang Euro-American socket outlet with earth, 16A Rated voltage: 250V AC Rated current: 16A Includes child safety shutter		
White	BC245	2TCZ212022R0060	1
Matt white	BC245-WM	2TCZ212022R3960	1
Space grey	BC245-SG	2TCZ212022R6360	1
Matt black	BC245-MB	2TCZ212022R4460	1
Champagne gold	BC245-CH	2TCZ212022R4160	1

	1 Gang Schuko socket, 16A Rated voltage: 250V AC Rated current: 16A Includes child safety shutter		
White	BC296	2TCZ212019R0060	1
Matt white	BC296-WM	2TCZ212019R3960	1
Space grey	BC296-SG	2TCZ212019R6360	1
Matt black	BC296-MB	2TCZ212019R4460	1
Champagne gold	BC296-CH	2TCZ212019R4160	1

Framia

Data outlets

Product	Article-No.	Order-No.	Pack/Qty
	1Gang TV outlet Dead-end feeder Frequency range: 5-1000MHz		
White	BC301	2TCZ213001R0010	1
Matt white	BC301-WM	2TCZ213001R3910	1
Space grey	BC301-SG	2TCZ213001R6310	1
Matt black	BC301-MB	2TCZ213001R4410	1
Champagne gold	BC301-CH	2TCZ213001R4110	1

	2 Gang TV & FM outlet Dead-end feeder Frequency range: 5-1000MHz		
White	BC312	2TCZ213004R0010	1
Matt white	BC312-WM	2TCZ213004R3910	1
Space grey	BC312-SG	2TCZ213004R6310	1
Matt black	BC312-MB	2TCZ213004R4410	1
Champagne gold	BC312-CH	2TCZ213004R4110	1

	1 Gang Telephone outlet RJ11 type connection 4-pole UTP		
White	BC321	2TCZ213005R0010	1
Matt white	BC321-WM	2TCZ213005R3910	1
Space grey	BC321-SG	2TCZ213005R6310	1
Matt black	BC321-MB	2TCZ213005R4410	1
Champagne gold	BC321-CH	2TCZ213005R4110	1

	2 Gang TV/Telephone outlet Frequency range: 5-1000MHz RJ11 type connection		
White	BC324	2TCZ213007R0010	1
Matt white	BC324-WM	2TCZ213007R3910	1
Space grey	BC324-SG	2TCZ213007R6310	1
Matt black	BC324-MB	2TCZ213007R4410	1
Champagne gold	BC324-CH	2TCZ213007R4110	1

Product	Article-No.	Order-No.	Pack/Qty
	1 Gang SAT socket outlet F-Type, isolated Frequency range: 5-1000MHz		
White	BC309	2TCZ213002R0010	1
Matt white	BC309-WM	2TCZ213002R3910	1
Space grey	BC309-SG	2TCZ213002R6310	1
Matt black	BC309-MB	2TCZ213002R4410	1
Champagne gold	BC309-CH	2TCZ213002R4110	1

	3 Gang TV,SAT & FM outlet Dead-end feeder Frequency range: 5-1000MHz F-Type, isolated		
White	BC313	2TCZ213003R0010	1
Matt white	BC313-WM	2TCZ213003R3910	1
Space grey	BC313-SG	2TCZ213003R6310	1
Matt black	BC313-MB	2TCZ213003R4410	1
Champagne gold	BC313-CH	2TCZ213003R4110	1

	2 Gang Telephone outlet RJ11 type connection 4-pole UTP		
White	BC322	2TCZ213006R0010	1
Matt white	BC322-WM	2TCZ213006R3910	1
Space grey	BC322-SG	2TCZ213006R6310	1
Matt black	BC322-MB	2TCZ213006R4410	1
Champagne gold	BC322-CH	2TCZ213006R4110	1

	2 Gang TV/Data outlet Frequency range: 5-1000MHz RJ45 Cat.5e 8-pole UTP		
White	BC325	2TCZ213008R0010	1
Matt white	BC325-WM	2TCZ213008R3910	1
Space grey	BC325-SG	2TCZ213008R6310	1
Matt black	BC325-MB	2TCZ213008R4410	1
Champagne gold	BC325-CH	2TCZ213008R4110	1

Framia

Data outlets

Product	Article-No.	Order-No.	Pack/Qty
	2 Gang Telephone & Data outlet RJ45 Cat.5e 8-pole UTP		
White	BC323	2TCZ213009R0010	1
Matt white	BC323-WM	2TCZ213009R3910	1
Space grey	BC323-SG	2TCZ213009R6310	1
Matt black	BC323-MB	2TCZ213009R4410	1
Champagne gold	BC323-CH	2TCZ213009R4110	1

	2 Gang Data outlet RJ45 Cat.5e 8-pole UTP		
White	BC332	2TCZ213011R0010	1
Matt white	BC332-WM	2TCZ213011R3910	1
Space grey	BC332-SG	2TCZ213011R6310	1
Matt black	BC332-MB	2TCZ213011R4410	1
Champagne gold	BC332-CH	2TCZ213011R4110	1

	2 Gang Data outlet RJ45 Cat.6 8-pole UTP		
White	BC329	2TCZ213013R0010	1
Matt white	BC329-WM	2TCZ213013R3910	1
Space grey	BC329-SG	2TCZ213013R6310	1
Matt black	BC329-MB	2TCZ213013R4410	1
Champagne gold	BC329-CH	2TCZ213013R4110	1

	2 Gang Data outlet RJ45 Cat.6a 8-pole UTP		
White	BC317	2TCZ213015R0010	1
Matt white	BC317-WM	2TCZ213015R3910	1
Space grey	BC317-SG	2TCZ213015R6310	1
Matt black	BC317-MB	2TCZ213015R4410	1
Champagne gold	BC317-CH	2TCZ213015R4110	1

Product	Article-No.	Order-No.	Pack/Qty
	1 Gang Data outlet RJ45 Cat.5e 8-pole UTP		
White	BC331	2TCZ213010R0010	1
Matt white	BC331-WM	2TCZ213010R3910	1
Space grey	BC331-SG	2TCZ213010R6310	1
Matt black	BC331-MB	2TCZ213010R4410	1
Champagne gold	BC331-CH	2TCZ213010R4110	1

	1 Gang Data outlet RJ45 Cat.6 8-pole UTP		
White	BC333	2TCZ213012R0010	1
Matt white	BC333-WM	2TCZ213012R3910	1
Space grey	BC333-SG	2TCZ213012R6310	1
Matt black	BC333-MB	2TCZ213012R4410	1
Champagne gold	BC333-CH	2TCZ213012R4110	1

	1 Gang Data outlet RJ45 Cat.6a 8-pole UTP		
White	BC318	2TCZ213014R0010	1
Matt white	BC318-WM	2TCZ213014R3910	1
Space grey	BC318-SG	2TCZ213014R6310	1
Matt black	BC318-MB	2TCZ213014R4410	1
Champagne gold	BC318-CH	2TCZ213014R4110	1

	1 Gang Data outlet Housing		
White	BC331-H	2TCZ213016R0010	1
Matt white	BC331-H-WM	2TCZ213016R3910	1
Space grey	BC331-H-SG	2TCZ213016R6310	1
Matt black	BC331-H-MB	2TCZ213016R4410	1
Champagne gold	BC331-H-CH	2TCZ213016R4110	1

Framia

Data outlets

Product	Article-No.	Order-No.	Pack/Qty
---------	-------------	-----------	----------



2 Gang Data outlet Housing

White	BC332-H	2TCZ213017R0010	1
Matt white	BC332-H-WM	2TCZ213017R3910	1
Space grey	BC332-H-SG	2TCZ213017R6310	1
Matt black	BC332-H-MB	2TCZ213017R4410	1
Champagne gold	BC332-H-CH	2TCZ213017R4110	1

Framia

Function control

Product	Article-No.	Order-No.	Pack/Qty
	Shaver socket outlet Input: 230V, 50Hz/60Hz Output: 115V/230V, 20VA		
White	BC401	2TCZ214001R0010	1
Matt white	BC401-WM	2TCZ214001R3910	1
Space grey	BC401-SG	2TCZ214001R6310	1
Matt black	BC401-MB	2TCZ214001R4410	1
Champagne gold	BC401-CH	2TCZ214001R4110	1

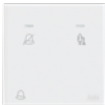
	Push button DND/MUR with bell symbol, 10A Rated voltage: 250V AC Rated current: 10A Includes red / green indication and bell sign		
White	BC403	2TCZ214003R0030	1
Matt white	BC403-WM	2TCZ214003R3930	1
Space grey	BC403-SG	2TCZ214003R6330	1
Matt black	BC403-MB	2TCZ214003R4430	1
Champagne gold	BC403-CH	2TCZ214003R4130	1

	LED dimmer Rated voltage: 220V-240V AC Frequency: 50-60Hz Load power range: 3-150VA μ Load type: - Adjustable LED - Incandescent lamp - 220V main halogen lamp		
White	BC405	2TCZ214006R0010	1
Matt white	BC405-WM	2TCZ214006R3910	1
Space grey	BC405-SG	2TCZ214006R6310	1
Matt black	BC405-MB	2TCZ214006R4410	1
Champagne gold	BC405-CH	2TCZ214006R4110	1

	Fan regulator Rated voltage: 220V AC Frequency: 50-60Hz Adjustment range: 500-25VA μ (from high to low)		
White	BC422	2TCZ214007R0010	1
Matt white	BC422-WM	2TCZ214007R3910	1
Space grey	BC422-SG	2TCZ214007R6310	1
Matt black	BC422-MB	2TCZ214007R4410	1
Champagne gold	BC422-CH	2TCZ214007R4110	1

Product	Article-No.	Order-No.	Pack/Qty
	Electronic Card switch, 16A Rated voltage: 250V AC Rated current: 16A Load compatibility: - Incandescent lamps: 4000W - Motors: 200VA - Fluorescent lamps: 200VA - Self-ballasted lamps: 100VA Time delay: 30s~45s Includes LED indicator		
White	BC402	2TCZ214002R0060	1
Matt white	BC402-WM	2TCZ214002R3960	1
Space grey	BC402-SG	2TCZ214002R6360	1
Matt black	BC402-MB	2TCZ214002R4460	1
Champagne gold	BC402-CH	2TCZ214002R4160	1

	2 Gang Switch DND/MUR with LED, 10A Rated voltage: 250V AC Rated current: 10A Interlocked gangs Includes red / green indication and bell sign		
White	BC493	2TCZ214004R0030	1
Matt white	BC493-WM	2TCZ214004R3930	1
Space grey	BC493-SG	2TCZ214004R6330	1
Matt black	BC493-MB	2TCZ214004R4430	1
Champagne gold	BC493-CH	2TCZ214004R4130	1

	Rotary dimmer Rated voltage: 220V AC Frequency: 50-60Hz Adjustment range: 25-500VA μ Load type: - Incandescent lamp - 220V main halogen lamp		
White	BC412	2TCZ214005R0010	1
Matt white	BC412-WM	2TCZ214005R3910	1
Space grey	BC412-SG	2TCZ214005R6310	1
Matt black	BC412-MB	2TCZ214005R4410	1
Champagne gold	BC412-CH	2TCZ214005R4110	1

Framia

FCU & Flex outlets / Accessories

Product	Article-No.	Order-No.	Pack/Qty
	Fused connection unit, 13A Rated voltage: 250V AC Rated current: 13A		
White	BC506	2TCZ215001R0040	1
Matt white	BC506-WM	2TCZ215001R3940	1
Space grey	BC506-SG	2TCZ215001R6340	1
Matt black	BC506-MB	2TCZ215001R4440	1
Champagne gold	BC506-CH	2TCZ215001R4140	1

	Switched Fused connection unit, 13A Rated voltage: 250V AC Rated current: 13A Double pole switch		
White	BC508	2TCZ215011R0040	1
Matt white	BC508-WM	2TCZ215011R3940	1
Space grey	BC508-SG	2TCZ215011R6340	1
Matt black	BC508-MB	2TCZ215011R4440	1
Champagne gold	BC508-CH	2TCZ215011R4140	1

	Flex outlet 25A Rated voltage: 250V AC Rated current: 25A		
White	BC589	2TCZ215004R0070	1
Matt white	BC589-WM	2TCZ215004R3970	1
Space grey	BC589-SG	2TCZ215004R6370	1
Matt black	BC589-MB	2TCZ215004R4470	1
Champagne gold	BC589-CH	2TCZ215004R4170	1

	1 Gang Blank Plate		
White	BC504	2TCZ215006R0010	1
Matt white	BC504-WM	2TCZ215006R3910	1
Space grey	BC504-SG	2TCZ215006R6310	1
Matt black	BC504-MB	2TCZ215006R4410	1
Champagne gold	BC504-CH	2TCZ215006R4110	1

Product	Article-No.	Order-No.	Pack/Qty
	Switched Fused connection unit with LED, 13A Rated voltage: 250V AC Rated current: 13A Double pole switch LED indicator		
White	BC507	2TCZ215002R0040	1
Matt white	BC507-WM	2TCZ215002R3940	1
Space grey	BC507-SG	2TCZ215002R6340	1
Matt black	BC507-MB	2TCZ215002R4440	1
Champagne gold	BC507-CH	2TCZ215002R4140	1

	Fused connection unit with LED, 13A Rated voltage: 250V AC Rated current: 13A LED indicator		
White	BC577	2TCZ215003R0040	1
Matt white	BC577-WM	2TCZ215003R3940	1
Space grey	BC577-SG	2TCZ215003R6340	1
Matt black	BC577-MB	2TCZ215003R4440	1
Champagne gold	BC577-CH	2TCZ215003R4140	1

	Flex Outlet 45A Rated voltage: 250V AC Rated current: 45A		
White	BC590	2TCZ215005R0090	1
Matt white	BC590-WM	2TCZ215005R3990	1
Space grey	BC590-SG	2TCZ215005R6390	1
Matt black	BC590-MB	2TCZ215005R4490	1
Champagne gold	BC590-CH	2TCZ215005R4190	1

	2 Gang Blank Plate		
White	BC505	2TCZ215007R0010	1
Matt white	BC505-WM	2TCZ215007R3910	1
Space grey	BC505-SG	2TCZ215007R6310	1
Matt black	BC505-MB	2TCZ215007R4410	1
Champagne gold	BC505-CH	2TCZ215007R4110	1

Framia

FCU & Flex outlets / Accessories

Product	Article-No.	Order-No.	Pack/Qty
---------	-------------	-----------	----------



2 Gang frame

White	BC621	2TCZ215008R0010	1
Matt white	BC621-WM	2TCZ215008R3910	1
Space grey	BC621-SG	2TCZ215008R6310	1
Matt black	BC621-MB	2TCZ215008R4410	1
Champagne gold	BC621-CH	2TCZ215008R4110	1



4 Gang frame

White	BC641	2TCZ215010R0010	1
Matt white	BC641-WM	2TCZ215010R3910	1
Space grey	BC641-SG	2TCZ215010R6310	1
Matt black	BC641-MB	2TCZ215010R4410	1
Champagne gold	BC641-CH	2TCZ215010R4110	1

Product	Article-No.	Order-No.	Pack/Qty
---------	-------------	-----------	----------



3 Gang frame

White	BC631	2TCZ215009R0010	1
Matt white	BC631-WM	2TCZ215009R3910	1
Space grey	BC631-SG	2TCZ215009R6310	1
Matt black	BC631-MB	2TCZ215009R4410	1
Champagne gold	BC631-CH	2TCZ215009R4110	1

Framia

Dimensions

Dimensions for 1gang frames

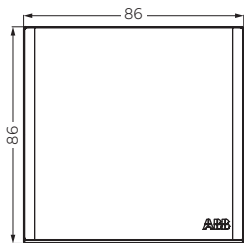

Distance between fixing screws for 1gang frames

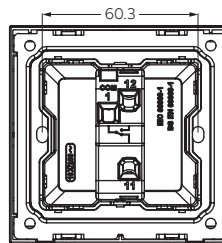

Dimensions for 2gang frames

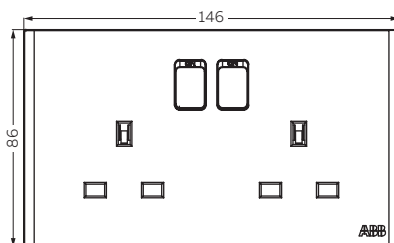

Distance between fixing screws for 2gang frames

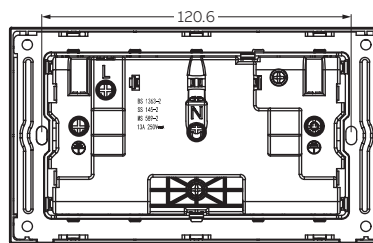

Dimensions for shaver socket

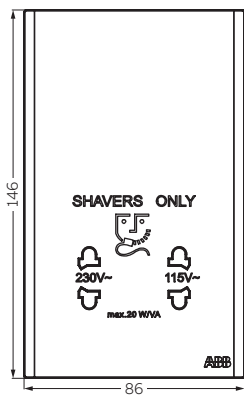

Distance between fixing screws for Shaver socket

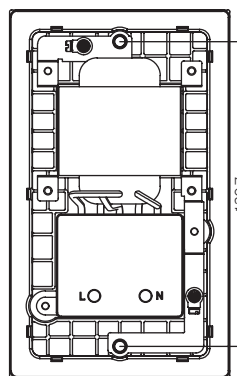

Framia

Wiring Diagrams

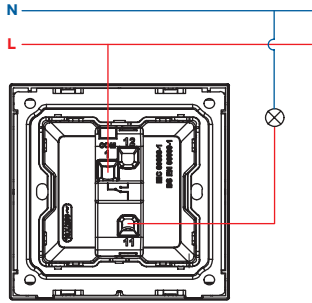

1G 1W switch

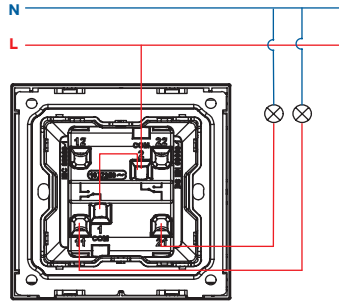

2G 1W switch

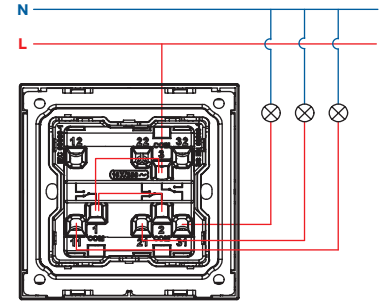

3G 1W switch

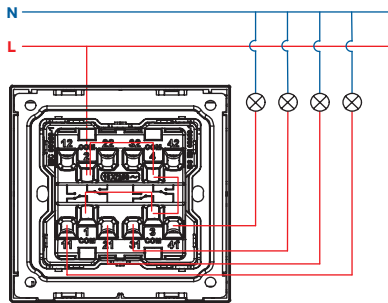

4G 1W switch

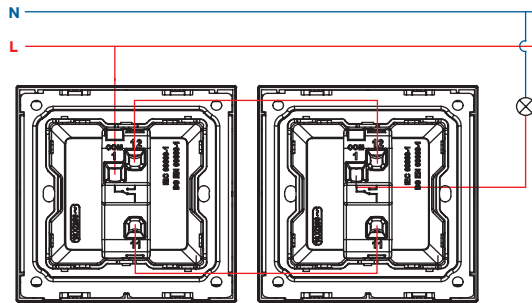

1G 2W switch

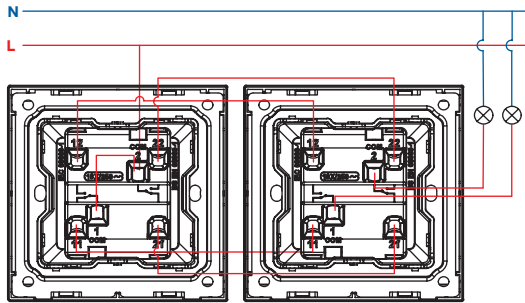

2G 2W switch

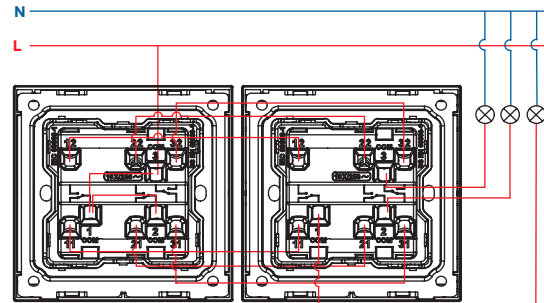

3G 2W switch

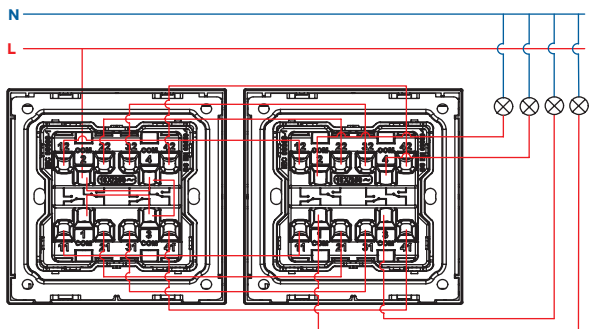

4G 2W switch

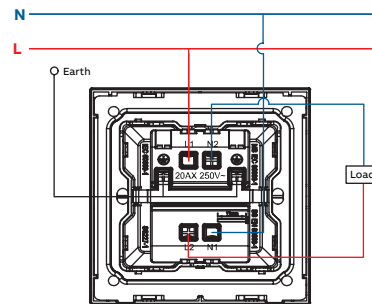

1G 1W switch 20AX DP

Framia

Wiring Diagrams

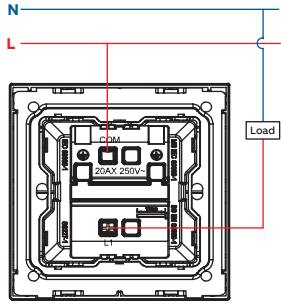

1G 1W switch 20AX

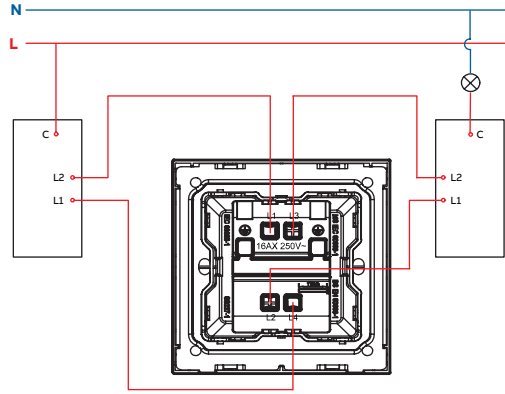

1G intermediate switch

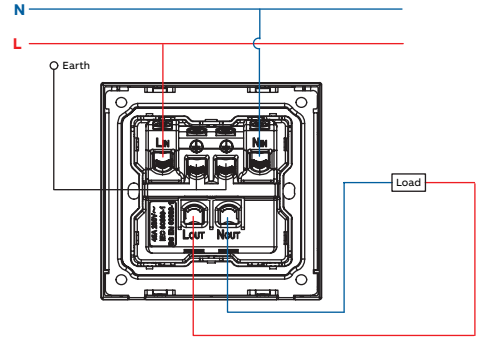

1G 1W switch 32A/45A DP

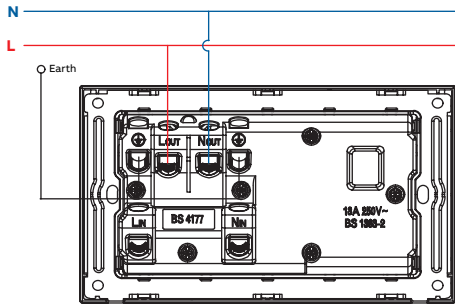

Cooker switch unit

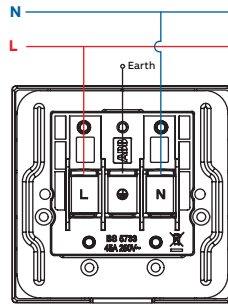

Flex outlet 45A

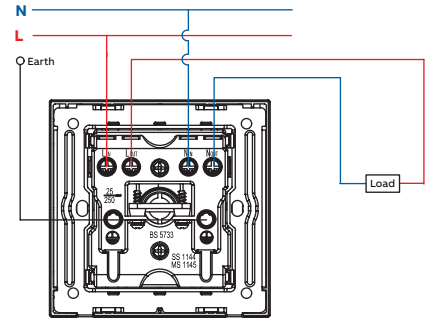

Flex outlet 25A

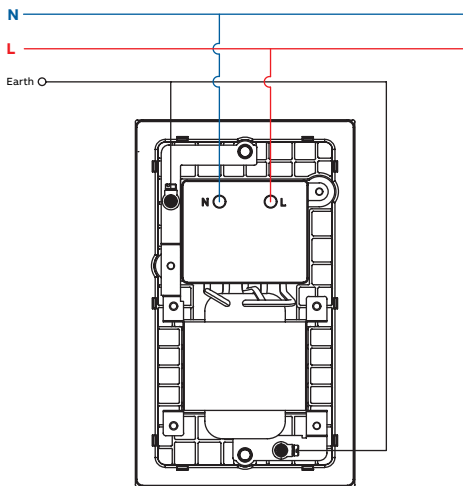

Shaver unit

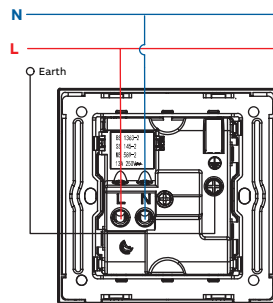

1G 13 A switched socket outlet

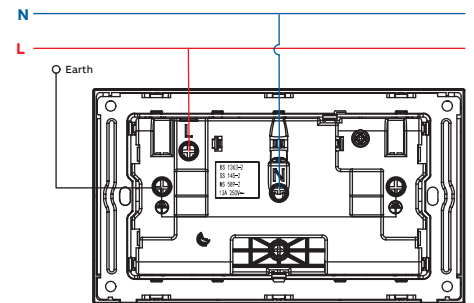

2G 13 A switched socket outlet

Framia

Wiring Diagrams

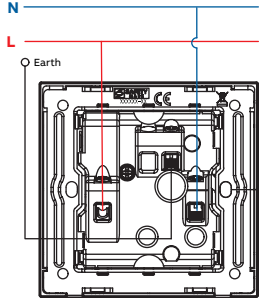

1G 5 A switched socket outlet

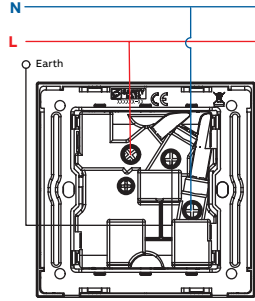

1G 15 A switched socket outlet

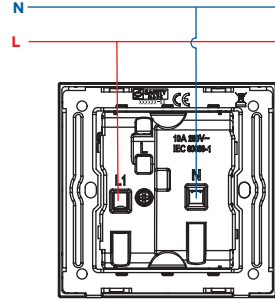

2G 10A Euro-American Switch Socket

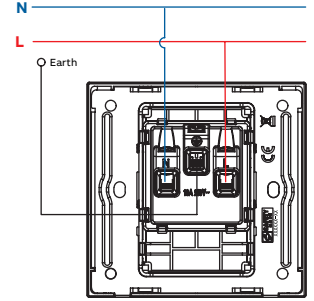

1G/2G 16A Euro-American Socket with Earth

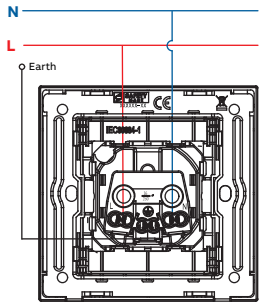

1G 16A SCHUKO Socket

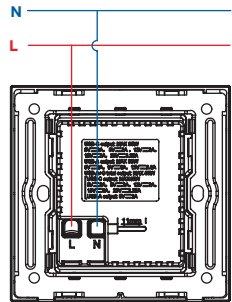

2G USB Charger, Type A+C

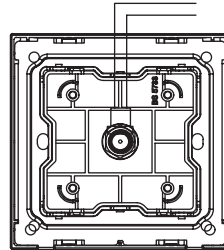

1G TV outlet

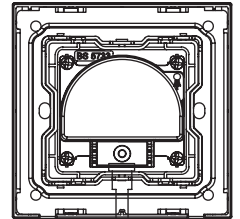

2G TV&FM / 3G TV, SAT&FM Outlet

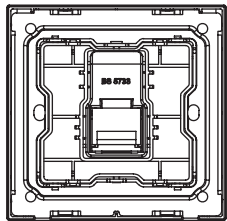

1G telephone outlet

WIRING DIAGRAM

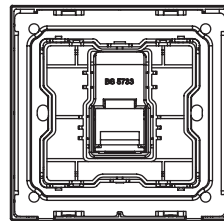
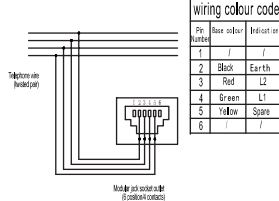

1G/2G data outlet

WIRING DIAGRAM

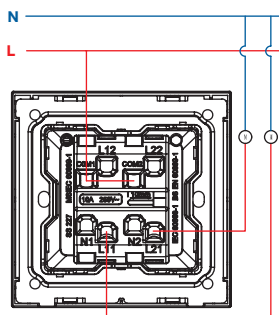
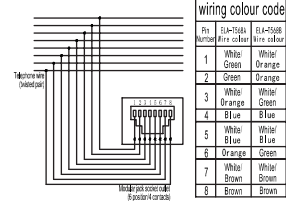

Blind Control Switch

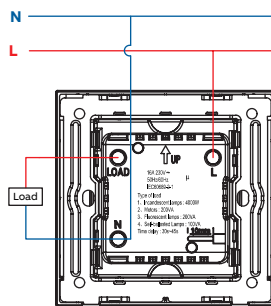

Electronic Card Switch

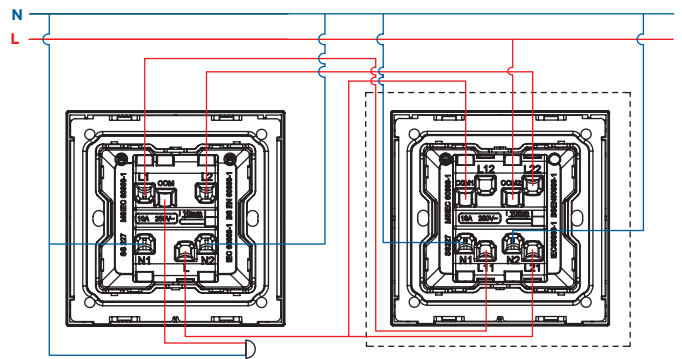

DND/MUR BELL Switch (OUTDOOR)

DND/MUR Switch (INDOOR)

Framia

Wiring Diagrams

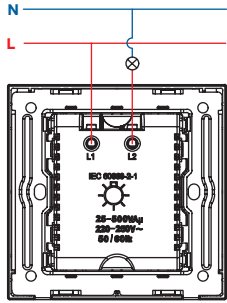

Rotary dimmer

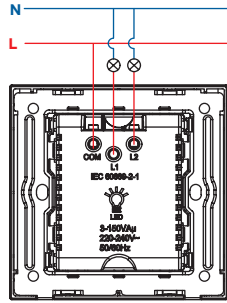

LED dimmer - 1 Way operation

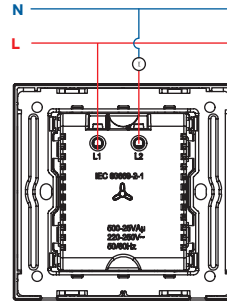

Fan regulator

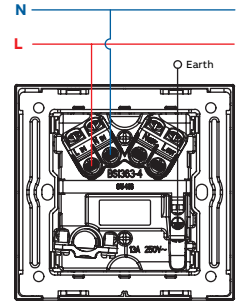

Fused connection unit

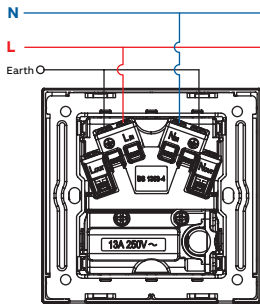

Fused switched connection unit

Framia

International standards

Product description	Standard	Standard
Switches	IEC60669-1 BSEN60669-1 SS 227 MSIEC60669-1	Switches for household and similar fixed electrical installations
Cooker control unit	BS4177 IEC60669-1 BS1363-2 SASO 2203	Specification for Cooker control units Switches for household and similar fixed electrical installations Specification for 13 A switched and unswitched socket outlets
13A sockets	BS1363-2 SS145-2 SASO 2203 MS 589-2	Specification for 13 A switched and unswitched socket outlets
15A sockets	BS546 SS472 MS1577	Two-pole and earthing-pin plugs, socket-outlets and socket-outlet adaptors
16A SCHUKO socket	IEC60884-1	Plugs and socket-outlets for household and similar purposes – Part 1: General requirements
Shaver socket	IEC60558-1 IEC60558-2-5	Safety of power transformers, power supply units and similar-Part 2-5: particular requirement for shaver transformers and shaver supply units
Dimmer/Fan regulator/Electronic card switch	IEC60669-2-1	Switches for household and similar fixed electrical installations-Part 2-1: Particular requirements-Electronic switches
Telecommunication	BS5733	General requirements for electrical accessories
FUSED CONNECTION UNIT	BS 1363-4 SS403	Specification for 13 A fused connection units switched and unswitched
Flex outlet 20A/45A	BS 5733 MS1144 MS1145	General requirements for electrical accessories
Plates	BS5733	General requirements for electrical accessories
Thermostat	IEC60730-1 / EN60730-1	Automatic electrical controls - Part 1: General requirements
	IEC60730-2-9 / EN60730-2-9	Automatic electrical controls - Part 2-9: Particular requirements for temperature sensing control
USB charger	IEC62368-1	Audio/video, information and communication technology equipment –Part 1: Safety requirements
	IEC 61000-6-3/ EN IEC 61000-6-3	Electromagnetic compatibility (EMC) - Part 6-3: Generic standards - Emission standard for equipment in residential environments
	IEC 61000-6-1/ EN IEC 61000-6-1	Electromagnetic compatibility (EMC) - Part 6-1: Generic standards - Immunity standard for residential, commercial and light-industrial environments

Contacts

UAE

ABB Industries LLC

Al Quoz Industrial Area 3
4th Interchange, St. No: 4 Dubai
Phone: 0097 1 (4) 3147500

Saudi Arabia

ABB Electrical Industries Co. Ltd.

Al Ahsa Street, Malaz 11371, Riyadh
Phone: 00966 11 4845600

Qatar

ABB LLC

Al Asmakh Tower, 15th floor
864 Hazm Zraig St., Bldg No. 49
Zone 63, Onaiza District, West Bay
PO BOX 8688
Phone: +974 4425 3888

Kuwait

ABB Engineering Technologies Co. (KSCC)

Alghunaim Commercial Twr, 2nd Flr, Al-Qibla Area
P.O.Box 4275, Safat-13043,
Abu Baker Al-Sadique Street
Phone: +965 2428626

Bahrain

ABB Technologies W.L.L.

Gulf Executive Offices, 12/Flr. Office 1023
Entrance 15, Road 3801, AlGudaibiya 338
Phone : +973 17810659

Oman

ABB LLC

218, Hatat House, P. O. Box 778,
131 Al Hamriya Muscat
Phone: 00968 24 567 410

Jordan

ABB Ltd.

Wasfi Altal Street - Building 356 - Khalda
P.O Box 926098 Amman 11190
Phone: +962 (6) 5507733

Pakistan

ABB Power & Automation (Pvt) Ltd.

P.E.C. Building, 97-A/D-1,
Liberty Market, Gulberg-III,
P.O. 2353, Lahore-54660, Pakistan
Phone: +92-42-32560740

Nigeria

ABBNG Limited

Plot 8C Metalbox road, off Acme
road Ogba, Ikeja, Lagos, Nigeria
Phone:+234907 000 0176

Sri Lanka

ABB India Limited

Level 35, West Tower, World Trade Center
Colombo 00100, Sri Lanka
Phone: +94 77 789 6445

Bangladesh

ABB Limited, The Glass House,
38 Gulshan Avenue (12th Floor)
Dhaka -1212
Phone: +88 02 98 56468 / 53412

Singapore

ABB Pte. Ltd.

2, Ayer Rajah Crescent
SGP - 139935
Phone: +65 6 776 5711

Malaysia

ABB Malaysia Sdn Bhd

Lot 608, Jalan Lagoon Selatan,
47500 Subang Jaya, Selangor.
Phone: +603 5628 4888

Vietnam

ABB Automation and Electrification (Vietnam) Company Ltd

12th Floor, REE tower, 9 Doan Van Bo street,
12th ward, 4 District, Ho Chi Minh City
Phone: +8428 3943 1488

Hong Kong

ABB (Hong Kong) Limited

Offices E&F, 5/F YHC Tower,
No. 1 Sheung Yuet Road, Kowloon Bay,
Kowloon, Hong Kong
Phone: +852 2929-3912

Indonesia

PT. ABB Sakti Industri

25th – 26th Fl. World Trade Center 3
Jl. Jend. Sudirman Kav. 29-31
Jakarta 12920
Phone: +62 21 2551 5555



—
new.abb.com/low-voltage/products/residential-products

